

ADVANCE

Sectional and counterweight spring doors



24V DC operators with control board and encoder

COD.	Art.	EN	Art.	Art.	Art.	OTHER CHARACTERISTICS
636052	ADVANCE		600		NET724N	<ul style="list-style-type: none"> • Motor with 2 channels encoder • Separated control board with box, programming by display, Open/Close external push buttons, LED courtesy light • Built-in receiver for up to 100 remote controls • 3 steps simplified programming • Quick connection of the motor in the track • Continuous adjustment of the stroke and forces • Secured programming procedure
636061	ADVANCE/XL		1200		NET724N/XL	

All models: control panel with box for wall mounting and 1 transmitter art. GT4 included. **Track not included.**

Iron track with belt:



COD.	Art.	CHARACTERISTICS
636090	AB16	Steel track with belt, 2 pcs, 1600+1600 mm ADVANCE series: useful stroke: 2776 mm
636093	AB20	Iron track with belt, 2 pcs., 2000 + 2000 mm ADVANCE series: useful stroke: 3576 mm

TECHNICAL INFO	ADVANCE	ADVANCE/XL
Motor power supply (V)	24V DC	
Maximum power absorption (W)	100	180
Max thrust (N)	600	1200
Duty cycle (cycles/hours)	20	25
230V AC ~ ± 10 % (50/60 Hz)	60	75
Operating temperature (°C)	-20 ÷ 50	
Speed (cm/s)	17	16
Weight with packing (Kg)	4	
Protection level	IPX0	

EXAMPLE OF A TYPICAL INSTALLATION

DOOR SIDE INSTALLATION

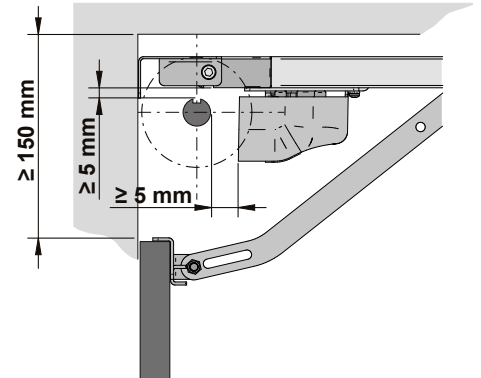
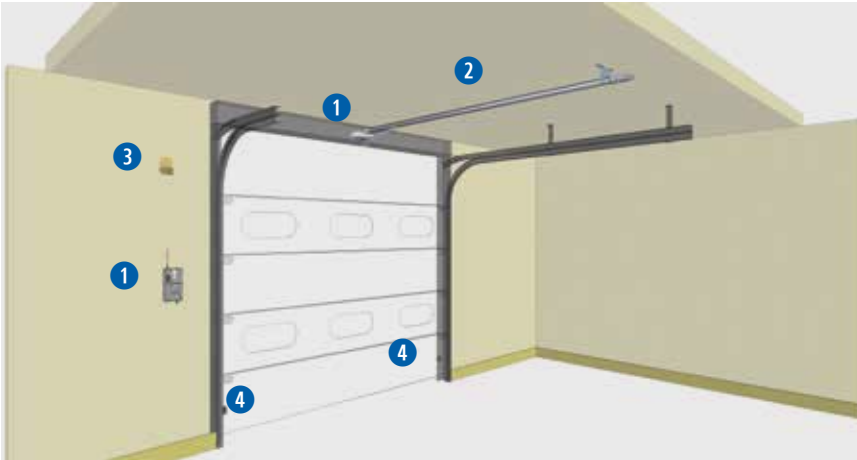

STANDARD SIDE INSTALLATION

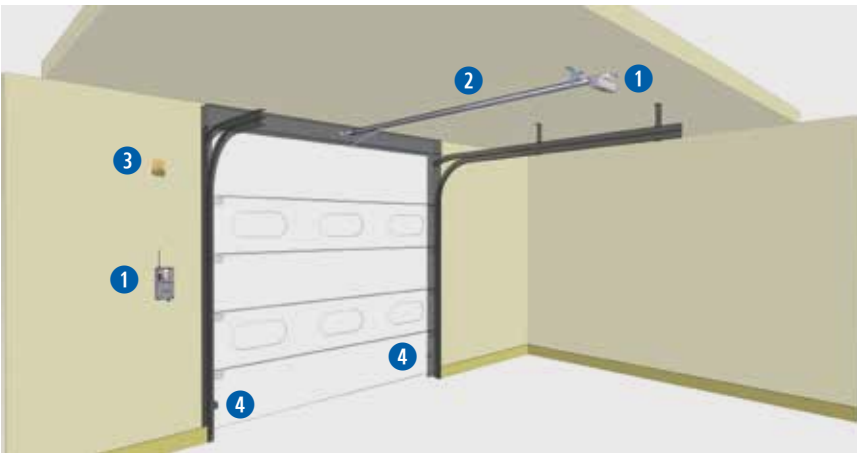

DIMENSIONS

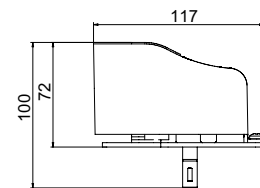
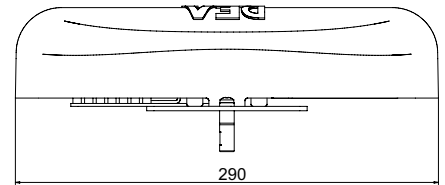



1

Art. ADVANCE
1 operator ADVANCE - 24V with separated control board



2

COD. 636090
Art. AB16
Iron track with belt, 2 pcs., 1600 + 1600 mm



3

COD. 661083
Art. AURA24
24V flashing light, LED, with integrated antenna, 433 MHz



4

COD. 662080
Art. LINEAR/XS
Pair of mini photoeye for outdoor installation. Maximum range 20m



4

COD. 672640
Art. GT4
White 4-channel remote control, 433 MHz, Rolling Code

SPECIFIC ACCESSORIES



COD. 639381
Art. AB/BACKET
Fixing plate set for track



COD. 639301
Art. AB/EXTENSION
1600mm extension for steel track art. AB16 complete with joint and 9450 mm full belt



COD. 639350
Art. 723
Arm adaptor for sectional doors



COD. 639321
Art. 721/AB
Unlocking device by cable (4m). To be used with art. 721M* or art. BLINDOS



COD. 639340
Art. 722
Arm to be used with counterweight doors



COD. 639590
Art. BAT/ADV
Battery set for ADVANCE/SPACE



COD. 639371
Art. 761C
Unlocking device by cable complete with hole cover lock



COD. 639372
Art. 762C
Unlocking device by cable with lock



COD. 179006
Art. 240E
Supplementary antenna for SPACE operators

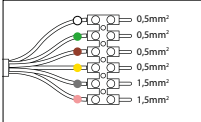

COD. 639600
Art. PLUG CABLE/ADV
Multi-section shielded cable for ADVANCE L=5m



COD. 665000
Art. BLINDOS
Aluminium safety enclosure, with European cylinder, ready for unlocking device by cable.

*art. 721M: available until stock lasts

OTHER ACCESSORIES



COD. 661083
Art. AURA24
24V flashing light, LED, with integrated antenna, 433 MHz



COD. 672630
Art. GT2
White 2-channel remote control, 433 MHz, Rolling Code



COD. 672640
Art. GT4
White 4-channel remote control, 433 MHz, Rolling Code



COD. 662080
Art. LINEAR/XS
Pair of mini photocell for outdoor installation. Maximum range 20m



COD. 663090
Art. GT-KEY
Metal vandal proof keyswitch with two contacts, surface mounted. Supplied with 2 keys.



COD. 663280
Art. DIGIRAD
Wireless keypad



COD. 663310
Art. DIGIPRO
Digikey with cable and proximity reader



COD. 663311
Art. DIGISLIM
Digikey with cable and proximity reader